



More Precision

thermoMETER // Non-contact infrared temperature sensors





thermoMETER CTLaserM1/M2

Non-contact IR temperature sensor with laser sighting for metal processing

- Measuring range 250°C to 2200°C
- 1μm/1.6μm measuring wavelength for accurate temperature measurements in difficult emissivity conditions
- Response time of 1ms
- Double laser marks exact spot size from 0.45mm
- For metal processing and measurements of metal oxides and ceramics
- Optical resolution 300:1 and 150:1 with selectable focus
- Up to 85°C ambient temperature without cooling, automatic laser switch-off at 50°C, up to 315°C with water cooled housing
- Selectable and scalable analog output, optional digital interfaces

Optical specifications thermoMETER CTLaserM1/M2

□ = smallest spot size (mm) / focal point (mm)

Standard Focus

1L/2L SF	150:1	20	18.3	16.5	14.8	13.1	11.3	9.6	8.5	7.3	9.8	13.5	17.2	23.4	29.6
1H/2H/H1 SF	300:1	12	10.9	9.7	8.6	7.5	6.3	5.2	4.5	3.7	5.1	7.3	9.4	13	16.5
distance in mm		0	150	300	450	600	750	900	1000	1100	1200	1350	1500	1750	2000

Close Focus

1L/2L CF2	150:1	20	13.7	7.3	1	8	15	22	36	50	64	78	92		
1H/2H/H1 CF2	300:1	12	8.2	4.3	0.5	4.7	8.8	13	21.3	29.7	38	46.3	54.7		
1L/2L CF3	150:1	20	15.3	10.7	6	1.3	6.6	12	22.6	33.3	43.9	54.6	65.2		
1H/2H/H1 CF3	300:1	12	9.2	6.4	3.5	0.7	3.9	7	13.4	19.8	26.1	32.4	38.8		
distance in mm		0	50	100	150	200	250	300	400	500	600	700	800		

Close Focus

1L/2L CF4	150:1	20	18.1	16.2	14.3	12.4	10.6	8.7	6.8	4.9	3	5.6	10.7	15.8	20.9
1H/2H/H1 CF4	300:1	12	10.8	9.7	8.5	7.3	6.2	5	3.8	2.7	1.5	3	6	9	12
distance in mm		0	50	100	150	200	250	300	350	400	450	500	600	700	800

Far Focus

1L/2L FF	150:1	20	20.5	21	21.5	22	22.5	23	23.3	24	28.9	41.1	53.3	62.5	
1H/2H/H1 FF	300:1	12	12	12	12	12	12	12	12	12	14.7	21.3	28	33	
distance in mm		0	450	900	1350	1800	2250	2700	3000	3600	4000	5000	6000	6750	

Model	CTLM-1LSF150-C3	CTLM-1HSF300-C3	CTLM-1H1SF300-C3	CTLM-2LSF150-C3	CTLM-2HSF300-C3	CTLM-2H1SF300-C3
Optical resolution	150:1	300:1		150:1	300:1	
Temperature range ¹	485 to 1050°C	650 to 1800°C	800 to 2200°C	250 to 800°C	385 to 1600°C	490 to 2000°C
Spectral range	1µm			1.6µm		
System accuracy ²	±(0.3% of reading +2°C)					
Repeatability ²	±(0.1% of reading +1°C)					
Temperature resolution	0.1°C	0.2°C		0.1°C	0.2°C	
Response time (90% signal) ³	1ms					
Emissivity/gain ¹	0.100 to 1.100					
Transmissivity/gain ¹	0.100 to 1.000					
Signal processing ¹	peak hold, valley hold, average; extended hold function with threshold and hysteresis					
Certificate of calibration	optional					
Outputs/analog	channel 1	0/4 to 20mA, 0 to 5/10V, thermocouple J, K				
Outputs/analog	optional	relays: 2 x 60VDC/42 VAC _{eff} ; 0.4A; electrically isolated				
Alarm output		open collector (24V / 50A)				
Outputs/digital	optional	USB, RS232, RS485, CAN, Profibus DP, Ethernet				
Output impedances	current output	mA max. 500Ω (with 5 - 36VDC)				
	voltage output	mV min. 100kΩ load impedance; thermocouple 20Ω				
Inputs	programmable functional inputs for external emissivity adjustment ambient temperature compensation, trigger (reset of hold functions)					
Cable length	3m (standard), 8m, 15m					
Power supply	8 to 36VDC; max. 160mA					
Laser	class II (635nm), 1mW, ON/OFF via controller or software					
Protection class	IP65 (NEMA-4)					
Ambient temperature	sensor: -20°C to 85°C (50°C if Laser ON); controller: 0°C to 85°C					
Storage temperature	sensor: -40°C to 85°C controller: -40°C to 85°C					
Relative humidity	10 to 95%, non-condensing					
Vibration	sensor	IEC 68-2-6: 3 G, 11-200Hz, any axis				
Shock	sensor	IEC 68-2-27: 50 G, 11ms, any axis				
Weight	sensor: 600g; controller: 420g					

¹ adjustable via controller or software

² ε=1, response time 1s; ambient temperature: 23±5°C

³ with dynamic adaption at low signal levels

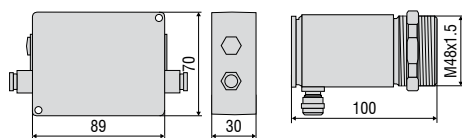

Product identification

CTLM -	1	L	SF150-	C3
			Cable length [3m (standard) / 8m / 15m]	
			Focus [SF / CF2 / CF3 / CF4 / FF]	
			Temperature range [L / H / H1]	
			Spectral range [1=1µm / 2=1.6µm]	
thermoMETER CTLaserM				

Accessories page 20 - 21

- Mounting bracket
- Air purge collar
- Rail mount adapter for controller
- Water cooled housing
- Interface kit
- Certificate of calibration



LASER LIGHT
DO NOT STARE INTO BEAM
CLASS 2 LASER
DIN EN 60825-1:2007
1mW / 630-650nm

CTLaser / CTLaserFAST / CTLaserGLASS / CTLaserM1/M2/M3/M5 / CTLaserCOMBUSTION

Controller

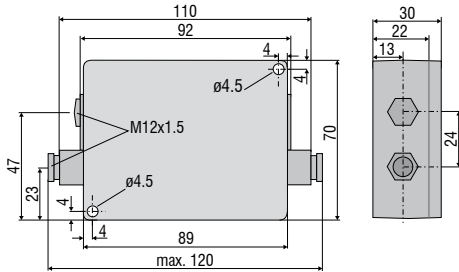

Sensor

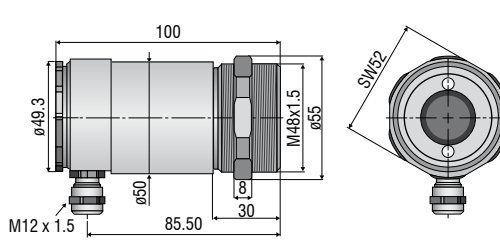

CTratioM1

Controller

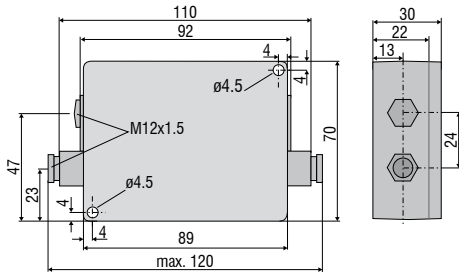

Sensor

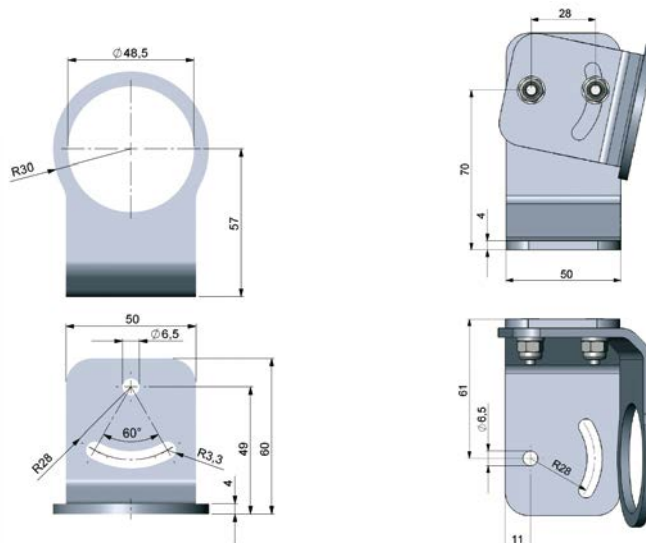
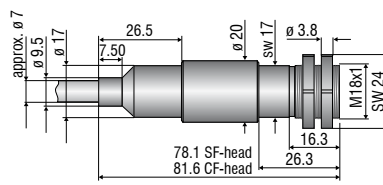

TM-FB-CTL Mounting bracket (fixed); included in CTL scope of supply

TM-AB-CTL Mounting bracket (adjustable)

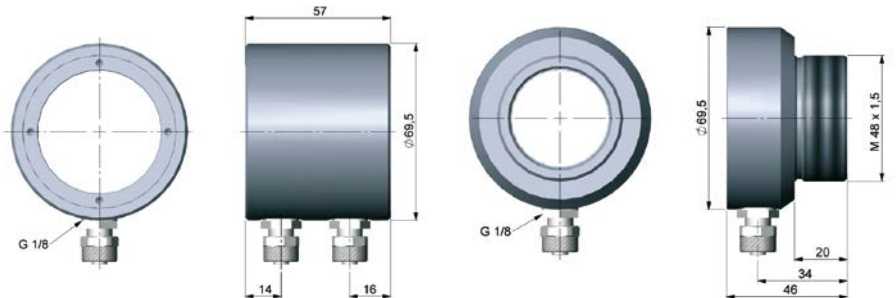

TM-W-CTL Water cooled housing and air purge collar TM-AP-CTL, mounted on adjustable mounting bracket TM-AB-CTL

TM-W-CTL Water cooled housing

TM-AP-CTL Air purge collar



Mechanical accessories		
Art. No.	Model	
2970238	TM-AB-CTL	Mounting bracket, adjustable, stainless steel
2970239	TM-AP-CTL	Air purge collar, stainless steel
2970240	TM-W-CTL	Water cooled housing, stainless steel, for ambient temperatures up to 175°C
2970241	TM-RAIL-CTL	Rail mount adapter for CTLaser controller
2970242	TM-COV-CTL	Closed cover for controller
2970243	TM-MN-CTL	Mounting nut, stainless steel (spare)
2970244	TM-FB-CTL	Mounting bracket, fixed, stainless steel (spare)
2970298	TM-A20UN-CTL	Screw adapter M48x1.5 on 20UN-2A screw including mounting nut

High temperature accessories		
Art. No.	Model	
2970366	TM-J-CTL	Cooling jacket (length 228mm, ø89mm) (conversion kit TM-CONK-CTL is required)
2970374	TM-CONK-CTL	Conversion kit for CTL on axial cable exit, for integration in cooling jacket
2970368	TM-JAB-CTL	Adjustable mounting bracket for cooling jacket
2970369	TM-MF-CTL	Mounting flange M48x1.5 for TM-PF-CTL
2970370	TM-AST300-CTL	Reflection protection tube M48x1.5, 300mm length
2970371	TM-PA-CTL	Pipe adapter M48x1.5
2970372	TM-RM-CTL	Furnace wall mount accessory for CTL (TM-MF-CTL, TM-AST300-CTL and TM-PA-CTL)
2970412	TM-PF-CTL	Pipe flange M48x1.5 for directly mounting a CTL sensor
2970487	TM-CJA-CTL	Cooling Jacket Advanced - universal cooling jacket for CSLaser, CTLaser and CTVideo / CSVideo up to 315°C

Calibration		
Art. No.	Model	
2970253	TM-CERT-CTL	Certificate of calibration
2970324	TM-HTCERT-CTL	Certificate of calibration for CTLaser M1-/M2-/M3-/M5-/G-sensors

Interfaces		
Art. No.	Model	
2970245	TM-USBK-CTL	USB interface, computer cable, CompactConnect software second cable gland for controller
2970246	TM-RS232K-CTL	RS232 interface, computer cable, CompactConnect software, second cable gland for controller
2970338	TM-RS485USBK-CTL	RS485-USB-adapter, incl. PC cable, CompactConnect software and CTmulti, second cable gland for use with interface board TM-RS485B-CTL
2970248	TM-RS485B-CTL	RS485 interface board incl. second cable gland
2970249	TM-CANK-CTL	CAN-Bus interface; protocol: CANopen Presets: module address20 (14H), 250kbaud, 0-60°C
2970250	TM-PFBDPK-CTL	Profibus-DPV1 interface with plug-in connection
2970251	TM-ETHNK-CTL	Ethernet-Kit: interface board, external Ethernet adapter, CompactConnect software, second cable gland
2970252	TM-RI-CTL	Relay interface: two electrically isolated relays, 60VDC/ 42VAC _{eff} 0.4A

Sensor cables and high temperature cables for CTLaser		
Art. No.	Model	
2970374	TM-CONK-CTL	Connector-Kit for cables with connector
4800254.003	TM-CB3C-CTL	Sensor cable with connector (3m)
4800254.003H	TM-CB3HC-CTL	High-temperature sensor cable (up to 180°C) with connector (3m)
4800254.008	TM-CB8C-CTL	Sensor cable with connector (8m)
4800254.008H	TM-CB8HC-CTL	High-temperature sensor cable (up to 180°C) with connector (8m)
4800254.015	TM-CB15C-CTL	Sensor cable with connector (15m)
4800254.015H	TM-CB15HC-CTL	High-temperature sensor cable (up to 180°C) with connector (15m)



TM-J-CTL Cooling jacket (length 228mm, ø 89mm) with adjustable mounting bracket TM-JAB-CTL; suitable for ambient temperatures up to 180°C

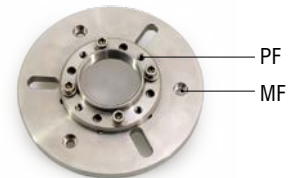

TM-PF-CTL and TM-MF-CTL mounting flange M48x1.5 for directly mounting a CTL sensor

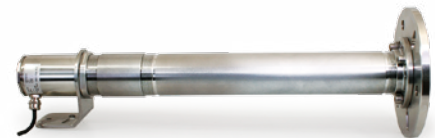

TM-RM-CTL Furnace wall mount accessory for CTLaser / CTratio: TM-MF-CTL, TM-PF-CTL, TM-AST300-CTL and TM-PA-CTL

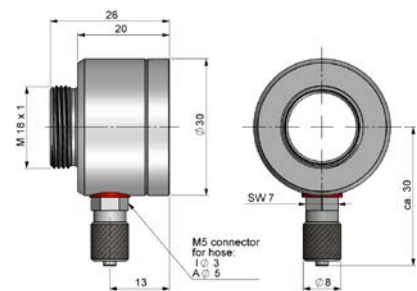

TM-AP-CTR Air purge collar

CTratio		
Art. No.	Model	
2970348	TM-FB-CTR	Mounting bracket, stainless steel, adjustable in one axis
2970395	TM-AP-CTR	Air purge collar, stainless steel
2970373	TM-RM-CTR	Furnace wall mount
2970351	TM-CERT-CTR	Certificate of calibration

Further IR temperature measurement devices from Micro-Epsilon



thermoIMAGER TIM
Compact USB thermal imaging cameras
for precise thermography



thermoMETER CTVideo/CSVideo
Infrared temperature sensors with crosshair
laser sighting and video output



thermoMETER Handheld
Innovative handheld pyrometer with laser
sighting for inspection and maintenance